

Article number: 0106055

Description: Retaining ring JV 38

## Measures

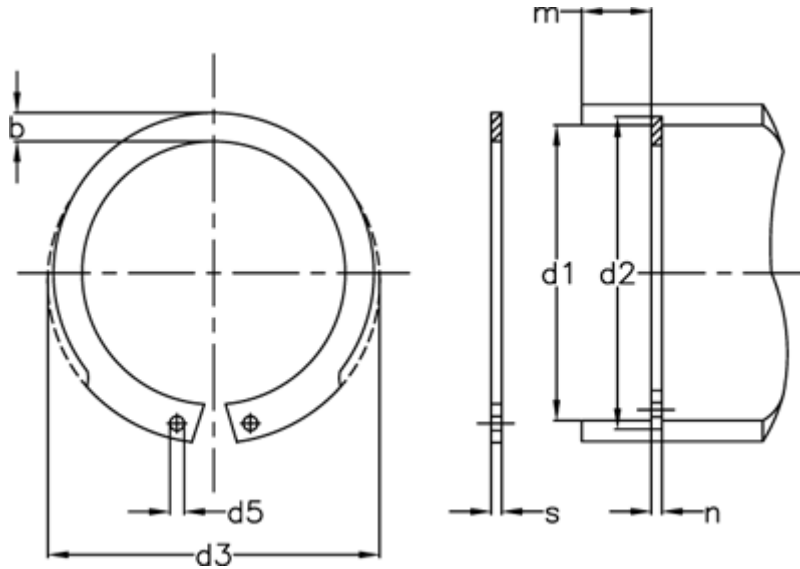

AN mm <sup>2</sup>	= 61	FRg kN	= 6.7	tol	= 0.1
b	= 3.8	FR kN	= 28.0	tol	= -0.06
d1	= 38	g	= 1.5	tol	= +0,50-0,25
d2	= 40.0	K kN-mm	= 51.2	tol	= +0,25
d3	= 40.8	m min	= 1.60	Tong	= ZGJ-1
d5 min	= 1.7	Nominal drive	= 3.8	Weight kg/1000	= 3.68
Description	= JV 38	s	= 1.50		
FN kN	= 10.20	t	= 1.00		